

Inductive Proximity Sensor

E2C-T

Proximity Sensor with Separate Amplifier for Detecting All Metals
 Incorporates Easy-to-Use Teaching Function for Simple Setup and Accurate, Reliable Sensing

- Three teaching modes allow easy setup and precise detection ability
- Slim 10 mm wide amplifier unit allows superior mounting flexibility
- Can be used with many existing sensor heads in the E2C family
- When connecting to the sensor terminals for CompoBus/S use, use the model E2C-T16 (which incorporates a connector)



Ordering Information

■ AMPLIFIER UNIT

Item	Part number
Amplifier	E2C-T11
Amplifier with built-in connector (for CompoBus/S)	E2C-T16

Note: No Sensor other than the ones listed is available.

E2C-T11

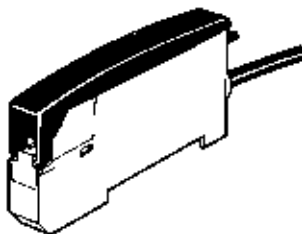

E2C-T16

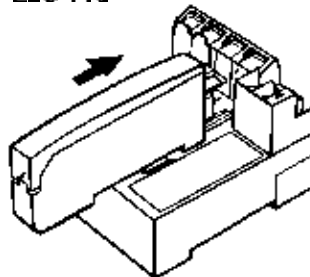

Mounts to the Sensor Terminals easily for CompoBus/S Use.

■ SENSOR HEADS

Appearance		Stable sensing range		Part number
		All temperature ranges	0°C to 40°C (32°F to 104°F)	
2 dia.	Un-shielded (See Note.)	0.5 mm	0.7 mm	E2C-CR5B2
3.5 dia.	Shielded 	0.8 mm	1.2 mm	E2C-CR8A
3.8 dia.		0.8 mm	1.2 mm	E2C-CR8B
M5		1 mm	1.5 mm	E2C-X1A
5.4 dia.		1 mm	1.5 mm	E2C-C1A
M8		1.5 mm	2 mm	E2C-X1R5A

Note: The E2C-CR5B2 with shielded construction cannot be embedded in metal.

Application Examples

■ SCREW HEIGHT DISCRIMINATION

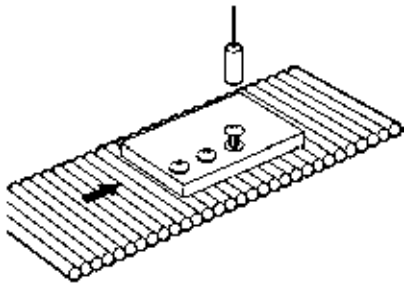

■ OBJECT LEVEL DISCRIMINATION

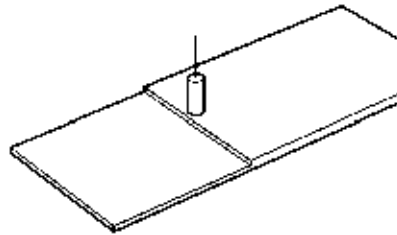

■ GRIP CONDITION MONITORING

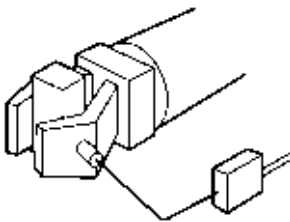

Specifications

■ E2C-T1 □ AMPLIFIER UNITS

Note: E2C-T16 can only be used as input circuit for CompoBus/S system. For Non-CompoBus/S applications, use E2C-T11.

Item		Sensor Head				
		E2C-CR5B2	E2C-CR8A E2C-CR8B	E2C-X1A E2C-C1A	E2C-X1R5A	
Supply voltage		12 to 24 VDC \pm 10% (operation: 10 to 26.4 VDC), ripple (p-p): \pm 10% max.				
Current consumption		50 mA max.				
Sensing distance adjustment range (See Note 1.)	Setting distance for teaching without sensing target (See Note 2.)	0.4 mm min.	0.72 mm min.	0.9 mm min.	1.35 mm min.	
	Setting distance for teaching with and without target object or positioning teaching	0°C to 40°C (32°F to 104°F)	0.1 to 0.7 mm	0.16 to 1.2 mm	0.2 to 1.5 mm	0.3 to 2 mm
		0°C to 55°C (32°F to 131°F)	0.1 to 0.5 mm	0.16 to 0.8 mm	0.2 to 1.0 m	0.3 to 1.5 mm
Temperature influence		\pm 25% max. of sensing distance at 23°C in the temperature range of 0°C to 55°C (32°F to 131°F)	\pm 10% max. of sensing distance at 23°C in the temperature range of 0°C to 55°C (32°F to 131°F)			
Ambient temperature	Operating	0°C to 55°C (32°F to 131°F) with no icing				
Ambient humidity	Operating	35% to 95%				
Differential travel		15% max. of sensing distance	10% max. of sensing distance			
Response time		Refer to the response frequency of the Proximity Sensor (next page).				
Control output		NPN open collector output of 100 mA max. at 26.4 V with a residual voltage of 1 V max. NO/NC selectable				
Cable length compensation		3 m	1, 2, or 3 m selectable			
Indicators		Operation indicator (orange) and stability indicator (green)				
Voltage influence		\pm 1% max. of sensing distance within a range of 90% to 110% of the rated power supply voltage				
Insulation resistance		50 M Ω min. at 500 VDC between current carrying parts and case				
Dielectric strength		1,000 VAC (50/60 Hz) for 1 min between current carrying parts and case				
Vibration resistance		Destruction: 10 to 55 Hz, 1.5-mm double amplitude for 2 hours each in X, Y, and Z directions				
Enclosure rating		IEC, IP50				
Weight		Approx. 70 g				

Note: 1. Perform positioning teaching within the stable sensing distance, or reset failures may result when the E2C-T is in operation. If a fine-difference teaching is performed with and without a target object, reset failures may result when the E2C-T is in operation – even if teaching is successful.

2. The above distances for teaching without a target object were measured without surrounding metal or background.

■ E2C-□ SENSOR HEADS

Item	Sensor Head			
	E2C-CR5B2	E2C-CR8A E2C-CR8B	E2C-X1A E2C-C1A	E2C-X1R5A
Target object	Ferrous metal (Refer to <i>Engineering Data</i> for non-ferrous metal as target objects)			
Standard target object	Iron: 5 x 5 x 1 mm			Iron: 8 x 8 x 1 mm
Stable sensing range (within whole rated temperature range)	0 to 0.5 mm	0 to 0.8 mm	0 to 1 mm	0 to 1.5 mm
Stable sensing range at 0°C to 40°C	0 to 0.7 mm	0 to 1.2 mm	0 to 1.5 mm	0 to 2 mm
Response frequency (See Note 1.)	1 kHz			800 Hz
Ambient temperature	Operating: -10°C to 55°C (14°F to 131°F)		Operating: -25°C to 70°C (-13°F to 158°F) with no icing	
Ambient humidity	Operating: 35% to 95%			
Temperature influence	±25% max. of sensing distance at 23°C in the temperature range of -10°C to 55°C (14°F to 131°F)		±15% max. of sensing distance at 23°C in the temperature range of -25°C to 70°C (-13°F to 158°F)	
Vibration resistance	Destruction: 10 to 55 Hz, 1.5-mm double amplitude for 2 hours each in X, Y, and Z directions			
Shock resistance	Destruction: 500 m/s ² (approx. 50G) three times each in X, Y, Z directions			
Enclosure rating	IEC60529 IP64 JEM IP64 (drip-proof)		IEC, IP67 (JEM IP67g, waterproof and oil-proof)	
Connection cable length (See Note 2.)	3-m shielded cable		3-m coaxial cable (standard length)	
Weight with 3-m cable	Approx. 10 g		Approx. 40 g	Approx. 45 g Approx. 50 g
Material	Case	Stainless steel		Brass
	Sensing surface	ABS resin		
	Cable	Polyethylene		

- Note: 1. The response frequency was measured by using standard target objects under the condition that the space between each pair of adjacent target objects is double the width of a single target object and the setting distance is half the maximum sensing distance.
2. The characteristic impedance of the coaxial cable for high-frequency use is 50 Ω.

Engineering Data

■ OPERATING RANGE (TYPICAL)

E2C-CR5B2

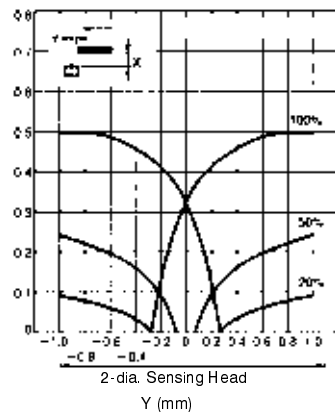

E2C-CR8□

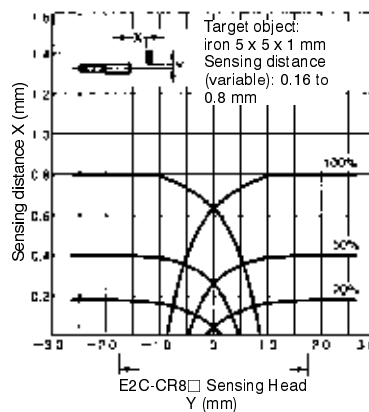

E2C-X1A/-C1A

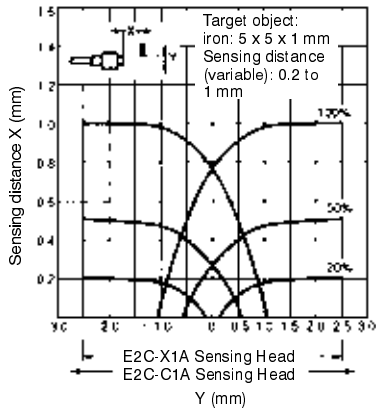

E2C-X1R5A

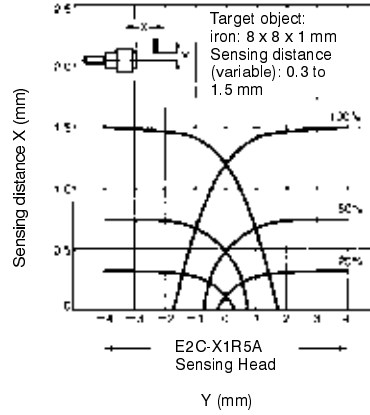

■ SENSING DISTANCE VS. TARGET OBJECT SIZE AND MATERIAL (TYPICAL)

E2C-CR5B2

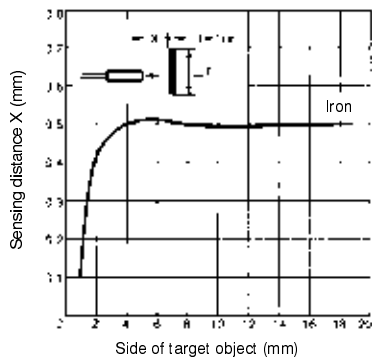

E2C-CR8

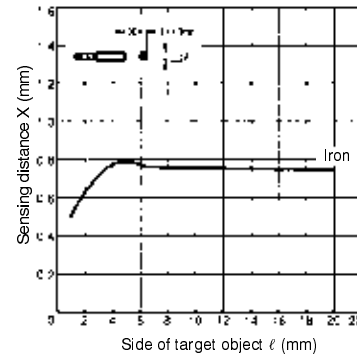

E2C-X1A/-C1A

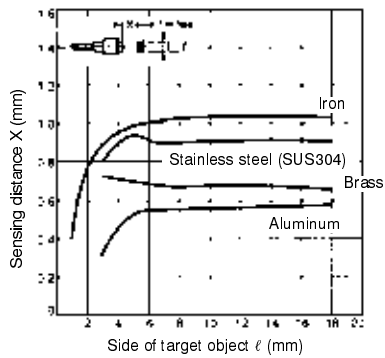

E2C-X1R5A

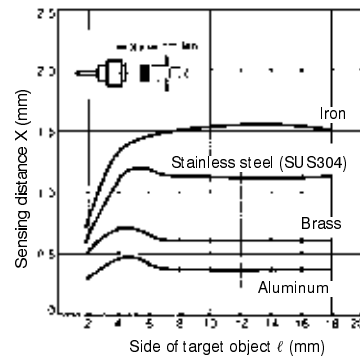

Nomenclature

SWITCHES AND FUNCTIONS

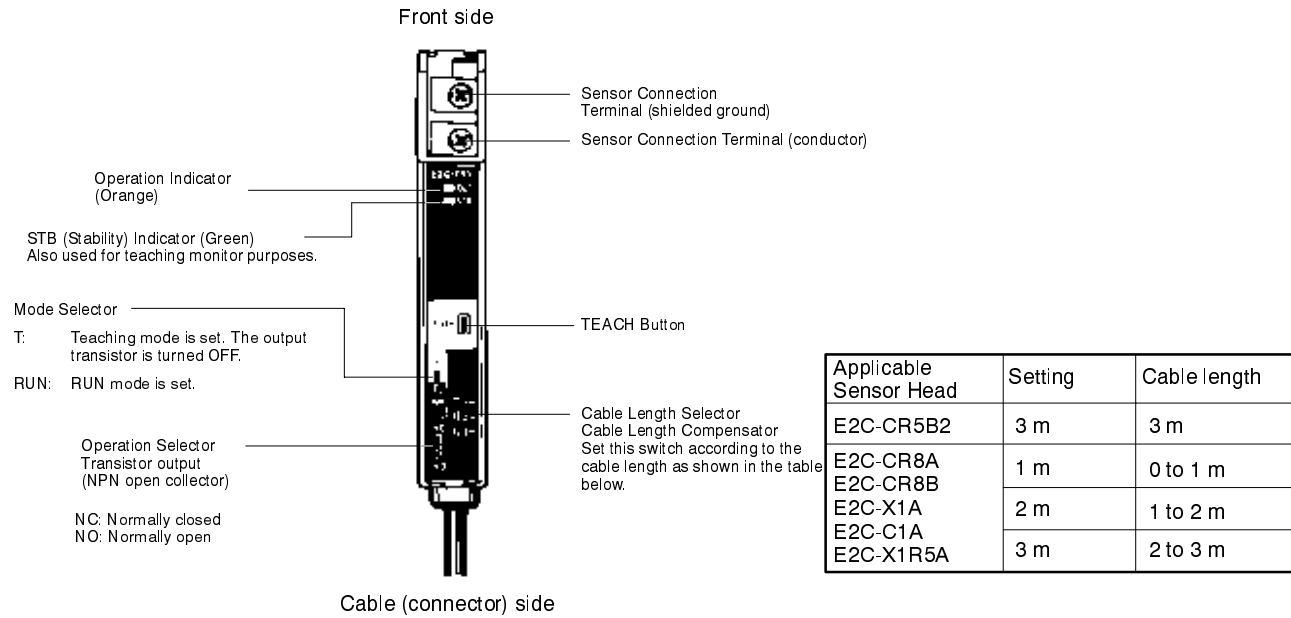

Operation

AUTOMATIC TEACHING

The E2C-T is used for object detection, level difference detection, and positioning, and the sensitivity of the E2C-T must be set according to the application. The following description provides information on the automatic teaching of the E2C-T for sensitivity adjustment.

Teaching Proximity Sensor with Separate Amplifier

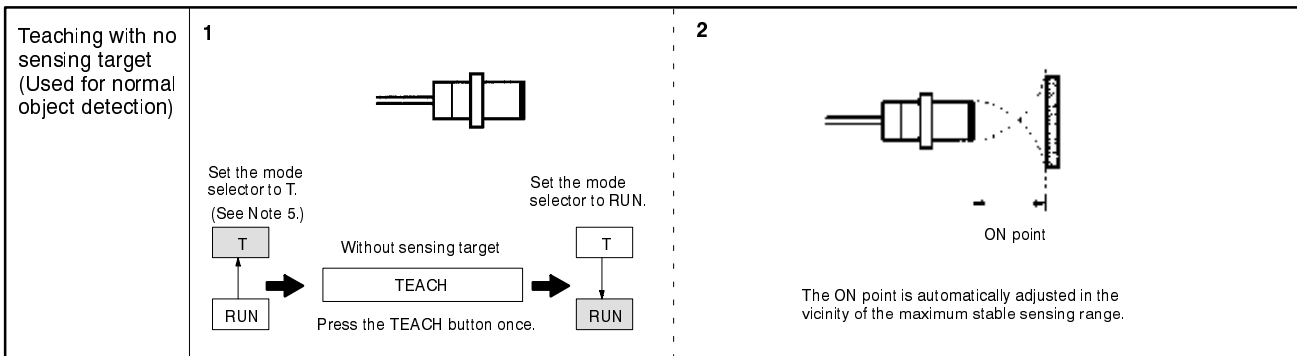

(This table continues on the next page.)

Teaching Proximity – continued from previous page

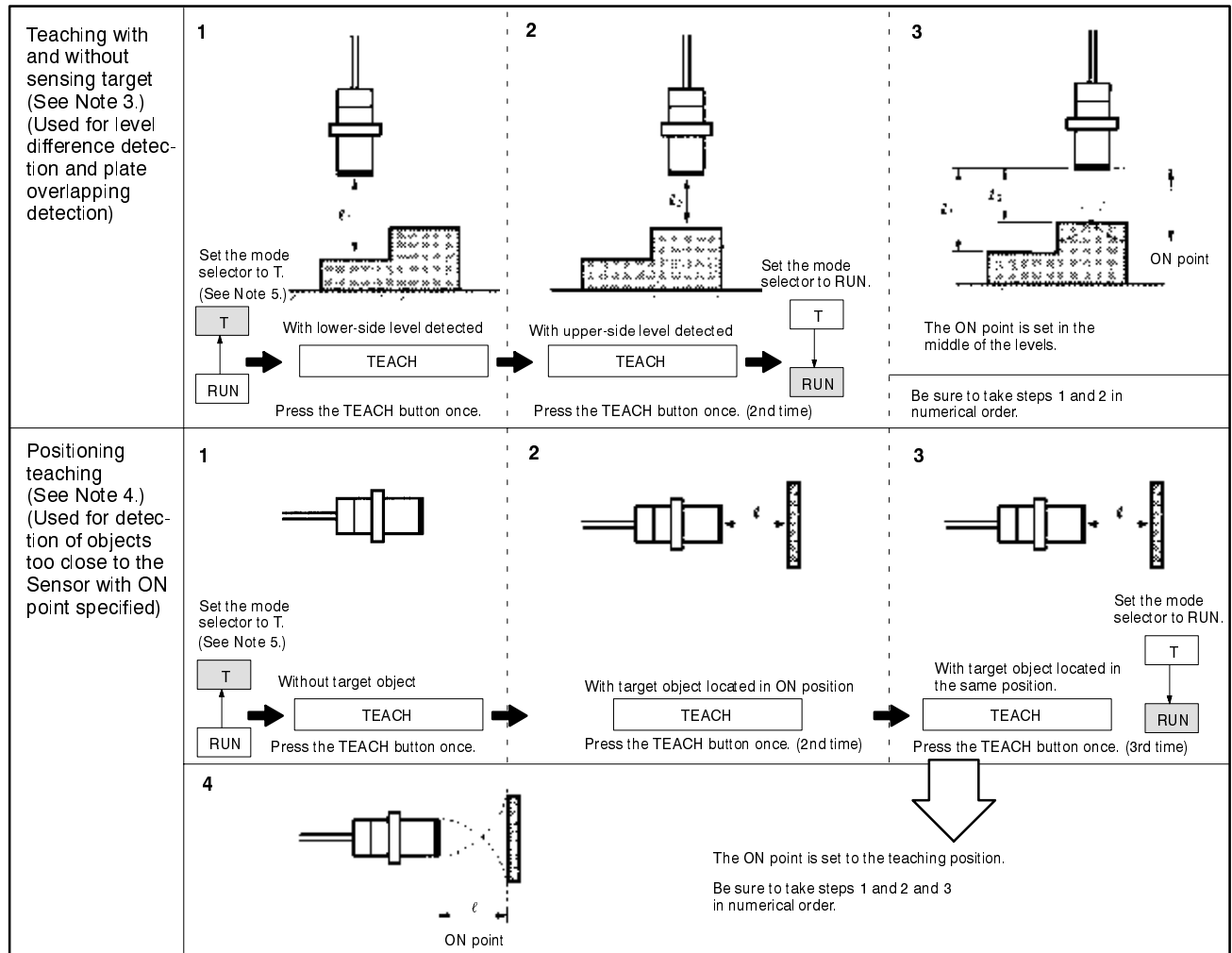

Note: 1. Refer to details in the *Sensitivity Setting (Automatic Teaching)* section of this data sheet.

2. Before use, be sure to perform the teaching of the E2C-T.

3. If a fine-difference teaching is performed, reset failures may result when the E2C-T is in operation even if the teaching is successful. Make sure that the E2C-T resets smoothly after the teaching.

4. Be sure to perform positioning teaching within the stable sensing distance range, or reset failures may result – even if teaching is successful. Be sure to check that the E2C-T can be reset after teaching. Refer to *Ratings* for the stability sensing range.

5. No transistor output will be ON if the mode selector is set to T, and a wrong signal may be output. The utmost attention is required for positioning teaching.

Sensitivity Setting (Automatic Teaching) in Detail

Type of teaching	Procedure
Teaching without a target object	<ol style="list-style-type: none"> 1. Locate the Sensor Head in sensing distance range. 2. Set the mode selector to T. 3. Press the TEACH button once without a target object. <ul style="list-style-type: none"> ↓ Wait for 1 s Teaching is OK Orange teaching indicator is ON. ↓ 4. Set the mode selector to RUN to complete the teaching operation. <p>* Teaching is not OK Orange teaching indicator flashes.</p> <p>↓</p> <p>Check the connection of the sensor cable and make sure that there is no target object. Then repeat steps 3 and 4.</p>
Teaching with and without a target object	<ol style="list-style-type: none"> 1. Locate the Sensor Head in sensing distance range. 2. Set the mode selector to T. 3. Move the target object to the position where the output should turn OFF. Then press the TEACH button once. (First time) <ul style="list-style-type: none"> ↓ Wait for 1 s Teaching is OK Orange teaching indicator is ON. ↓ 4. Move the target object to the position where the output should turn ON. Then press the TEACH button once. (Second time) <ul style="list-style-type: none"> ↓ Wait for 1 s Teaching is OK Orange indicator is ON, then the green indicator is ON. ↓ 5. Set the mode selector to RUN to complete the teaching operation. <p>* Teaching is not OK Orange teaching indicator flashes.</p> <p>↓</p> <p>Check the connection of the sensor cable and change the position of the target object and the set distance. Then repeat steps 3 through 5.</p>
Positioning teaching	<ol style="list-style-type: none"> 1. Locate the Sensor Head in sensing distance range. 2. Set the mode selector to T. 3. Press the TEACH button once without a target object. (First time) <ul style="list-style-type: none"> ↓ Wait for 1 s Teaching is OK Orange teaching indicator is ON. ↓ 4. Move the target object to the position where the output should turn ON. Then press the TEACH button once. (Second time) <ul style="list-style-type: none"> ↓ Wait for 1 s Teaching is OK Orange indicator is ON, then the green indicator is ON. ↓ 5. Press the teaching button once without changing the position of the target object. (Third time) <ul style="list-style-type: none"> ↓ Wait for 1 s Teaching is OK Green indicator is ON, then both the orange and green indicators are ON. ↓ 6. Set the mode selector to RUN to complete the teaching operation. <p>* Teaching is not OK Orange teaching indicator flashes.</p> <p>↓</p> <p>Check the connection of the sensor cable and change the position of the target object and the set distance. Then repeat steps 3 through 6.</p>

Note: Be sure to perform the teaching of the E2C-T before use. Once the teaching of the E2C-T is performed, the teaching data set in the E2C-T will be retained even after turning OFF the E2C-T.

■ TIMING CHARTS

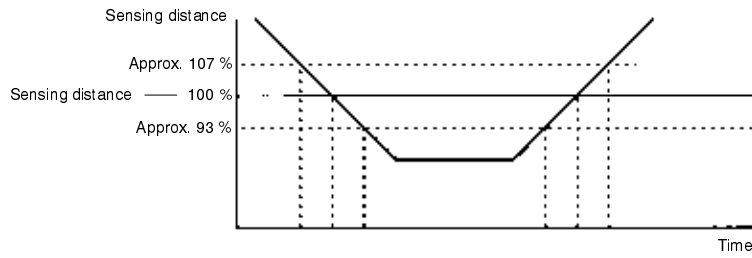

NO Setting

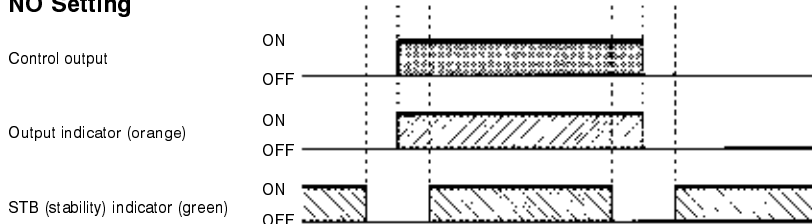

NC Setting

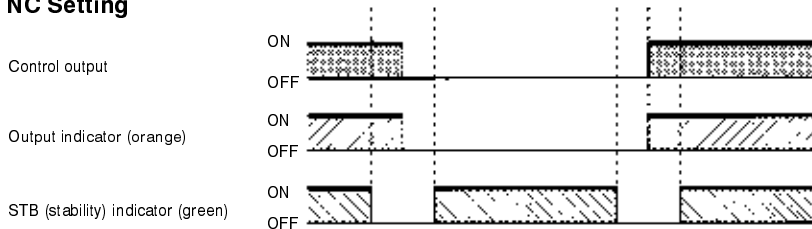

■ INDICATORS

The OUT indicator indicates the status of the control output transistor. The indicator will be ON when the transistor has control output (i. e., NPN open collector output).

If the operation selector is set to NO, the indicator will be ON when the target object is in the sensing distance range. If the operation selector is set to NC, the indicator will be ON when the target object is not in the sensing distance range.

The STB (stability) indicator indicates the excess gain of object detection or non-detection. The indicator will be ON when the target object is within approximately 93% of the sensing distance or at approximately 107% of the sensing distance or beyond.

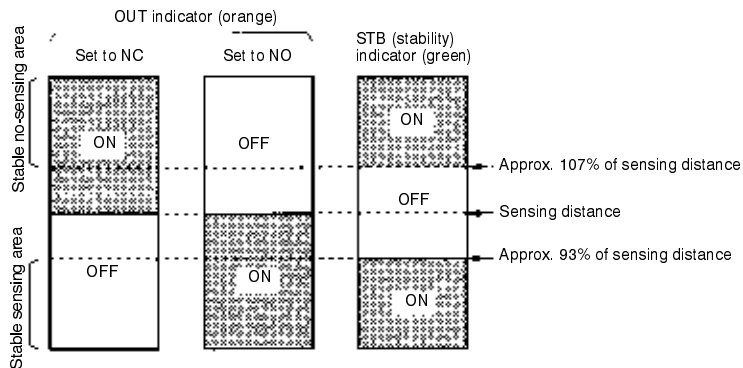

Dimensions

Unit: mm (inch)

AMPLIFIER UNITS

E2C-T11

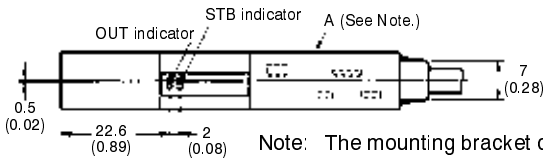
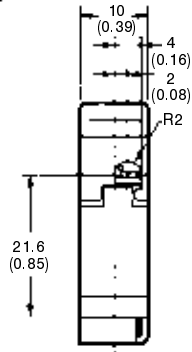
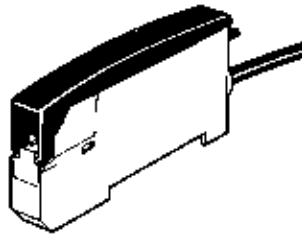

Note: The mounting bracket can also be mounted to side A.

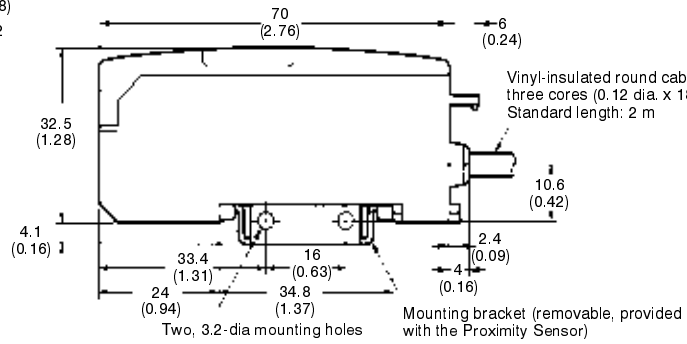

Mounting Holes

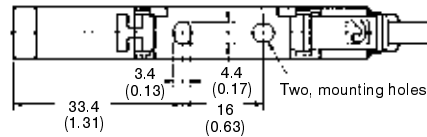
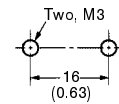

E2C-T16

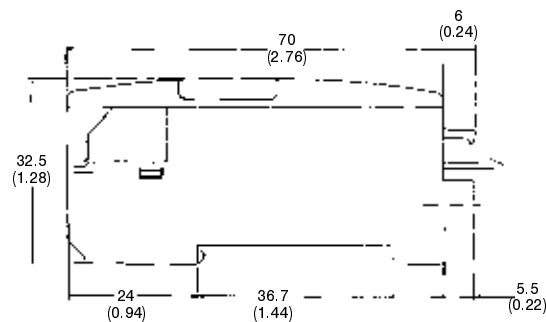
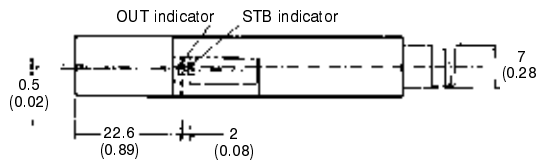
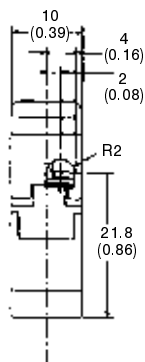
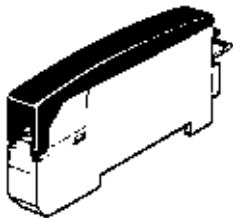

■ SENSOR HEADS

E2C-CR5B2

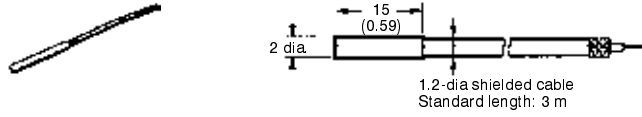

E2C-CR8A
E2C-CR8B

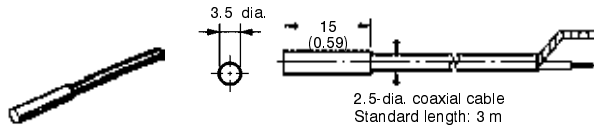

Note: 3.8-dia. coaxial cable is used for the E2C-CR8B.

E2C-X1A

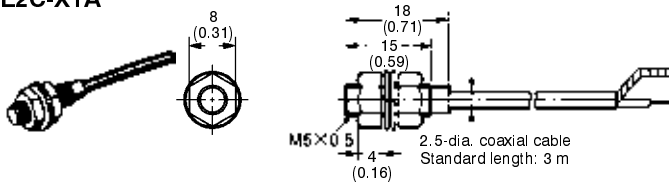

E2C-C1A

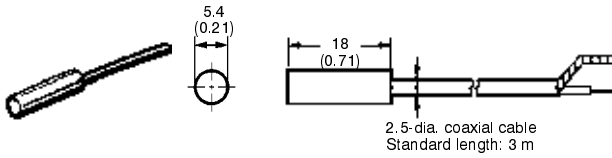

E2C-X1R5A

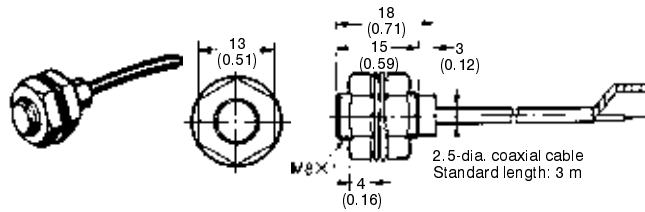

Installation

CONNECTION

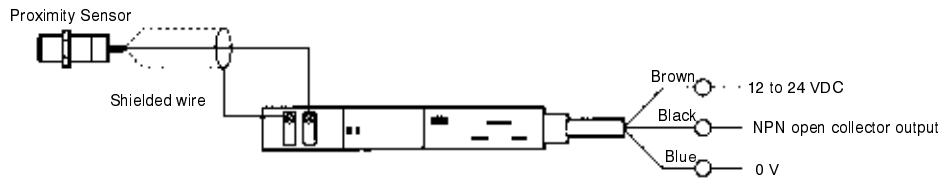

OUTPUT CIRCUIT

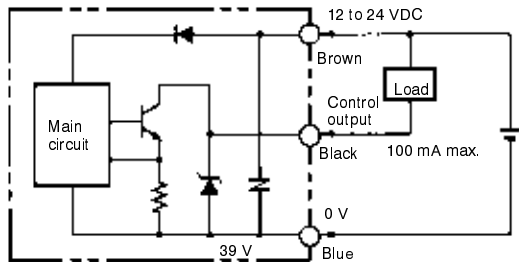

Precautions

POWER SUPPLY VOLTAGE

Do not impose voltage exceeding the rated voltage range or 100 VAC on the E2C-T, to avoid damaging the E2C-T.

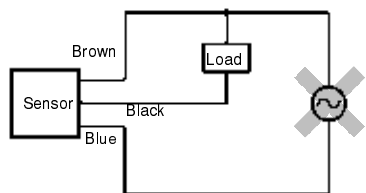

LOAD SHORT-CIRCUITING

Do not short-circuit the load, or the E2C-T may be damaged. The load short-circuit protection function is triggered provided that power within the rated voltage range is supplied to the E2C-T without a mistake in polarity.

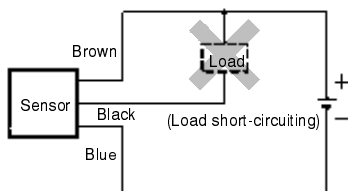

MOUNTING

Do not tighten the nut of the E2C-□ excessively. Tighten the nut with a toothed washer to the following torque.



Part number	Torque
E2C-X1A	0.98 N • m (10 kgf • cm)
E2C-X1R5A	2.0 N • m (20 kgf • cm)

Note: The above applies to a nut used with a toothed washer.

INCORRECT WIRING

To avoid damaging the E2C-T, observe the correct polarity when connecting the power supply and the load to the E2C-T.

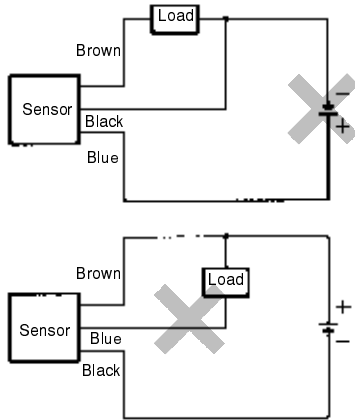

If a set screw is used for mounting a screwless, column model, make sure that the tightening torque does not exceed 0.2 N • m (2 kgf • cm).

M3 set screw end 7 to 11.5 mm

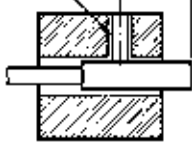

Y92E-F3R5 Bracket (3.5-dia. dedicated bracket sold separately)



Y92E-F5R4 (5.4 dia.) is sold separately.

Dimensions

Y92E-F3R5

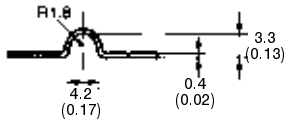

Y92E-F5R4

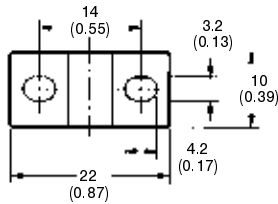
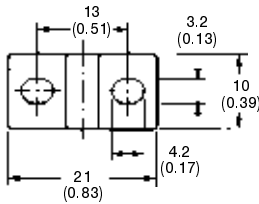
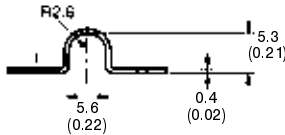

PROCESSING THE SENSOR CABLE ENDS

Because of the Amplifier Unit's slim construction, the end of the sensor cable connected to the E2C-□ must be processed as shown in the following illustration.

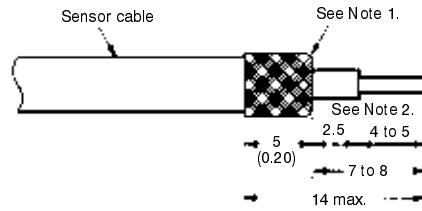

- Note: 1. Be sure to turn over the braided shield, so that none of its thin wires are left.
 2. Make sure that the insulation distance of at least 2.5 mm is maintained.

INFLUENCE OF SURROUNDING METAL

If the Sensor is embedded, be sure to separate the Sensor from surrounding metal objects, as shown in the following illustration.

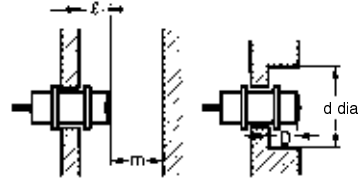

(mm)

Part number	ℓ	d	D	m
E2C-CR5B2	2	6	2	1.5
E2C-CR8□	0	(3.5)	0	2.4
E2C-X1A	0	(5)	0	3
E2C-C1A	0	(5.4)	0	3
E2C-X1R5A	0	(8)	0	4.5

- Note: Figures in parentheses indicate outer diameters of shielded models.
 Although the E2C-CR5B2 is a shielded model, this model cannot be embedded in metal.

MUTUAL INTERFERENCE

If more than one Sensor is located face-to-face or in parallel, be sure to maintain enough space, (as provided in the following diagram), between adjacent Sensors, to suppress mutual interference.

The mutual interference of the Sensors can be prevented by cable length selector settings. However, the result is a change in the coil characteristics of the Sensors, and the specified ratings may not be satisfied in all permissible temperature or sensing distance ranges. Test the operation of the Sensors before using them in an actual application.

- Note: The cable length of E2C-CR5B2 cannot be adjusted, so mutual interference cannot be manipulated for this sensor using cable length selector settings.

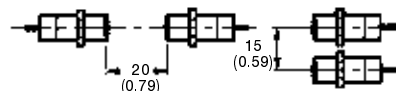

NOTE: DIMENSIONS SHOWN ARE IN MILLIMETERS. To convert millimeters to inches divide by 25.4.

OMRON

OMRON ELECTRONICS, INC.
One East Commerce Drive
Schaumburg, IL 60173
1-800-55-OMRON

OMRON CANADA, INC.
885 Milner Avenue
Scarborough, Ontario M1B 5V8
416-286-6465

Cat. No. E271-E3-1

6/98/1CM

Specifications subject to change without notice.

Printed in U.S.A.



ASH & ALAIN

3gfZaqlW 6[efqTgfad,Ž

ASH & ALAIN INDIA PVT LTD

S-100, F.I.E.E., Okhla Industrial Area, Phase-ii, New Delhi-110020(India)

Tel: 011-43797575 Fax: 011-43797574 E-mail: sales@ashalain.com